

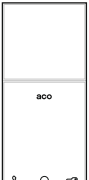









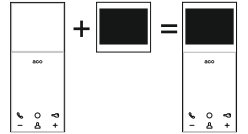

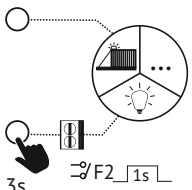
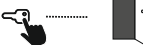

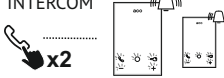
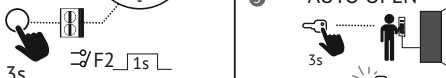
<p>video</p>  <p>MPRO800</p>	<p>audio / video</p>  <p>UPRO800V</p>	<p>LCD</p> <p>UP800 LCD 3,5"</p> 	<p>UPRO800V + LCD = MPRO800</p>  <p>INSTRUKCJA INSTALATORA INSTALLERS MANUAL INSTALLATIONSANWEISUNG L'INSTRUCTION DE L'INSTALLATEUR (UP800 LCD 3,5")</p> 	<table border="1"> <tr> <td>1</td> <td>2</td> <td>3</td> </tr> <tr> <td></td> <td></td> <td></td> </tr> <tr> <td>4</td> <td>5</td> <td>6</td> </tr> </table>	1	2	3				4	5	6
1	2	3											
4	5	6											

<p>1</p> 	<p>2</p>  <p>3s F2 1s</p>	<p>3</p> 	<p>4 6</p> 	<p>5</p>  <p>20s</p>
<p>1 INTERCOM</p>  <p>x2</p>	<p>3</p>  <p>3s</p> <p>AUTO OPEN</p>	<p>4</p> 	<p>5</p>  <p>35s</p>	<p>5</p>  <p>∞s</p>

<p>video</p> 					
<p>Intercom</p> 	 <p>x2</p>				<p>aco</p>

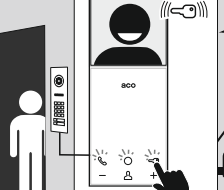

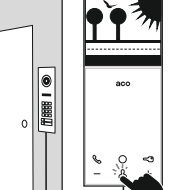
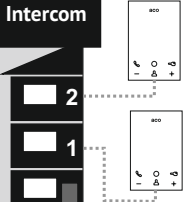
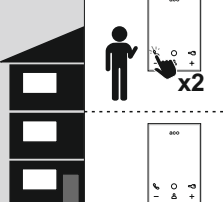
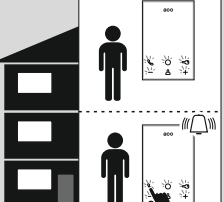
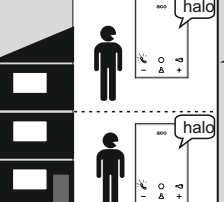
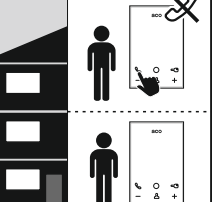
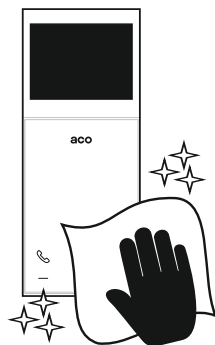
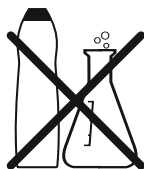
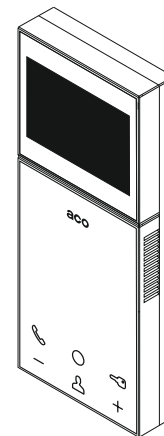
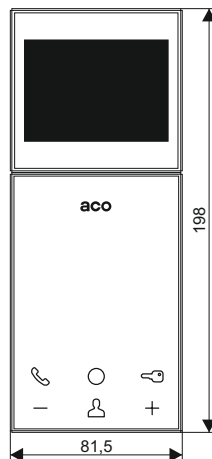
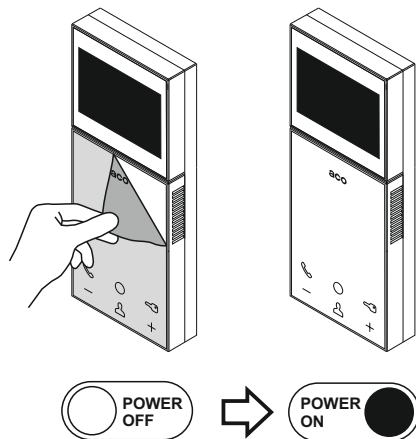
aco

PRODUCENT / PRODUCER / HERSTELLER / PRODUCTEUR

ACO Sp. z o.o. sp. komandytowa

ul. Diamentowa 7 62-002 Suchy Las, Poland

tel. +48 61 843 93 71

tel. +48 61 641 96 86

bok@aco.com.pl

export@aco.com.pl

www.aco.com.pl



Instrukcje oraz więcej informacji dostępne również na:

Instructions and more information also available on:

Instruktionen und weitere Informationen auch verfügbar auf:

www.support.aco.com.pl

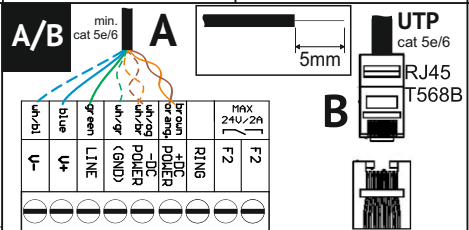
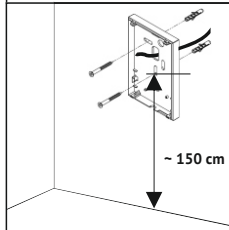
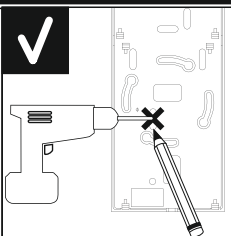
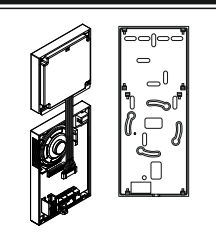
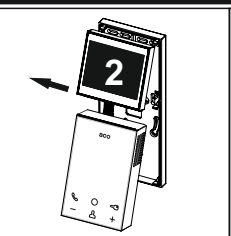
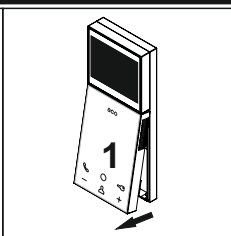
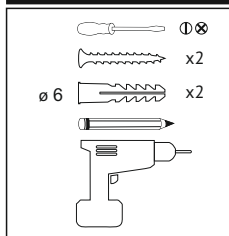

1. orange - white	-DC POWER	Power
2. orange	+DC POWER	
3. green - white	LINE -	
4. blue	V+ (V1+)	Video
5. blue - white	V- (V1-)	
6. green	LINE +	
7. brown - white	-DC POWER	Power
8. brown	+DC POWER	

-DC Power = GND
+DC Power = +15VDC

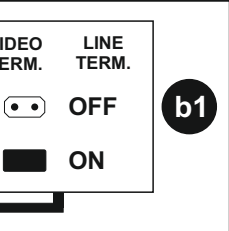
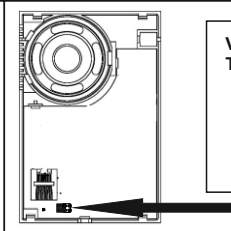
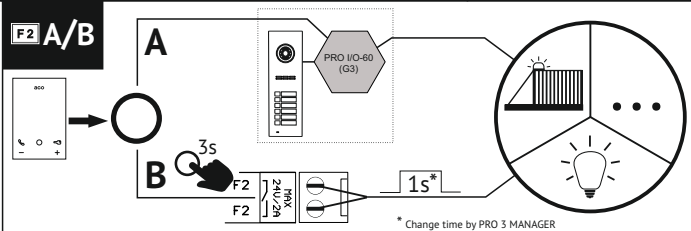
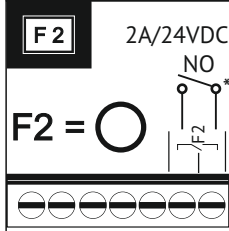
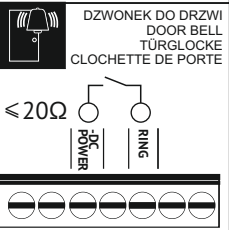

SET MONITOR ADDRESS

Address: 1 Address: 3
(1+2)

ON	1	2	4	8	16	32	64	1	2	M
CODE/ADDRESS	INTERCOM		CODE/ADDRESS		INTERCOM					

Address: 46 Address: ALL
(2+4+8+32) (0)

ON	1	2	4	8	16	32	64	1	2	M
CODE/ADDRESS	INTERCOM		CODE/ADDRESS		INTERCOM					

SET INTERCOM ADDRESS

ALL 1

ON	1	2	M
CODE/ADDRESS	INTERCOM		

2 3

ON	1	2	M
CODE/ADDRESS	INTERCOM		

SET INTERCOM MODE

Global Intercom (not related to monitor address)

Internal Intercom (related to monitor address) only 1 and 2

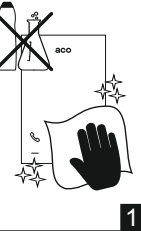
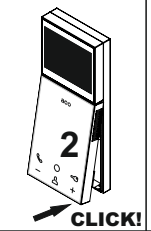
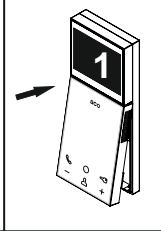
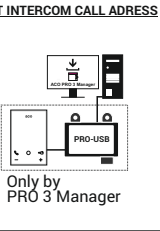

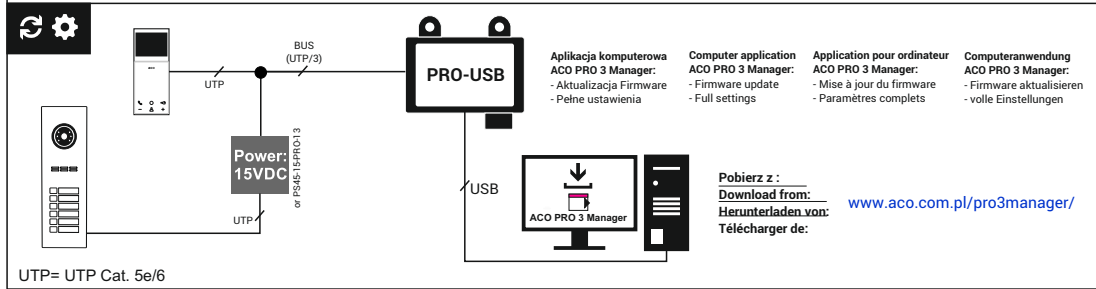
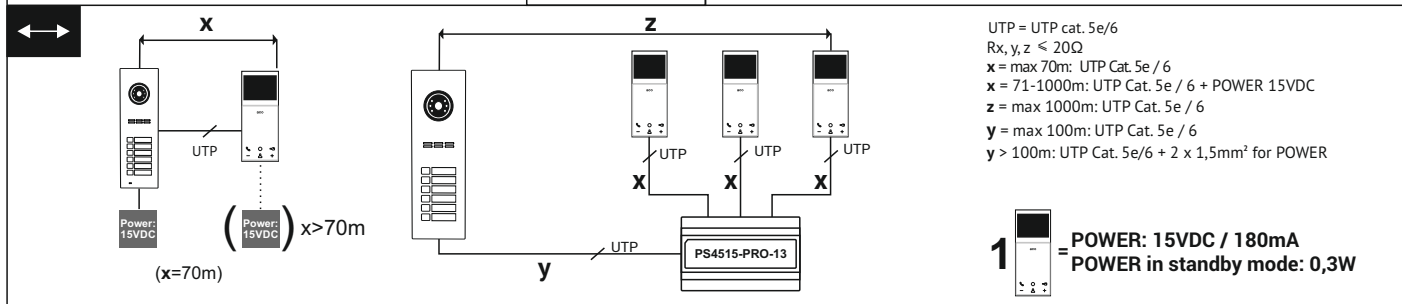
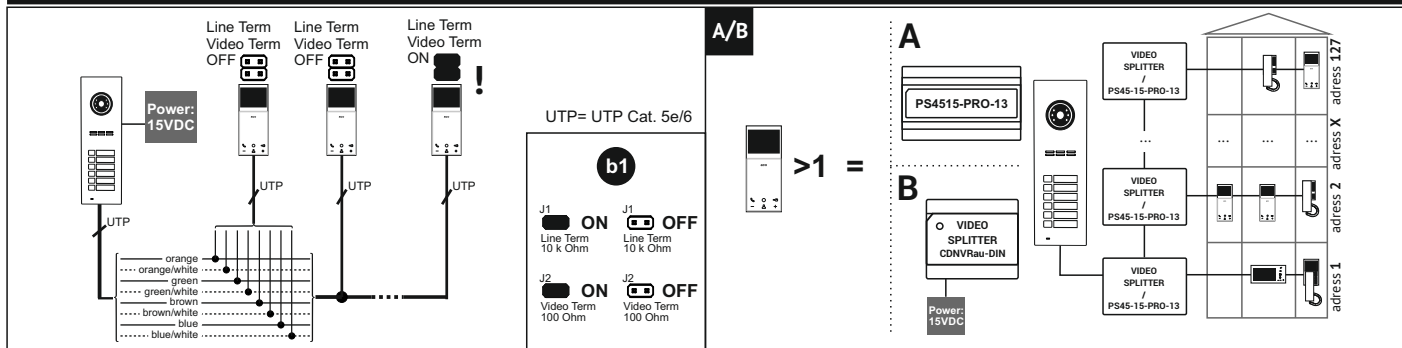

aco

PRODUCENT / PRODUCER / HERSTELLER / PRODUCTEUR
ACO Sp. z o.o. sp. komandytowa
 ul. Diamentowa 7 62-002 Suchy Las, Poland
 tel. +48 61 843 93 71
 tel. +48 61 641 96 86
 bok@aco.com.pl
 export@aco.com.pl
www.aco.com.pl

Instrukcje oraz więcej informacji dostępne również na:
 Instructions and more information also available on:
 Instruktionen und weitere Informationen auch verfügbar auf:
www.support.aco.com.pl

IU0126VA.2108